



Operator's Manual

Medium Power Countertop Induction Ranges with Knob Control

SAFETY PRECAUTIONS

To ensure safe operation, read the following statements and understand their meaning. This manual contains safety precautions which are explained below. Please read carefully.

⚠ WARNING

Warning is used to indicate the presence of a hazard that will or can cause severe personal injury or death.

⚠ CAUTION

Caution is used to indicate the presence of a hazard that will or can cause minor or major personal injury if the caution is ignored.

NOTICE: Notice is used to note information that is important but not hazard-related.

To reduce risk of injury or damage to the equipment:

- Unplug this equipment from the wall outlet when not in use.
- Use this equipment only in a flat, level position.
- To protect against electrical shock, do not immerse the cord or plug in water. Keep the cord away from heated surface. Do not let the cord hang over the edge of table or counter.
- As a precaution, persons using a pacemaker should stand back 12" (30 cm) from an operating unit. Studies have shown that the induction element will not disrupt a pacemaker.
- Keep all credit cards, driver licenses, and other items with a magnetic strip away from an operating unit. The unit's magnetic field will damage the information on these strips.
- The heating surface is made of a strong, non-porous material. However, should it crack or break, stop using and immediately unplug the unit. Cleaning solutions and spills could penetrate the broken cooktop and create a risk of electrical shock.
- Do not operate this equipment with a damaged cord or plug or if it is not functioning properly.
- Do not operate unattended. Closely supervise units operating in public areas and/or around children.
- Do not place any objects inside the air intake or exhaust panels.
- Do not attach any accessories to this equipment.

FUNCTION AND PURPOSE

This equipment is intended to heat food in commercial food service operations only. It is not intended for household, industrial, or laboratory use. It is intended to be used with induction-ready cookware.

Performance is optimized with Vollrath induction-ready cookware. Other cookware may have different properties which may alter performance.



Item No.	Watts	Plug
MPI4-1800	1800	NEMA 5-15P
MPI4-1440	1440	

TABLE OF CONTENTS

Environment Requirements page 2
 Clearance Requirements page 2
 Features and Controls page 3
 Operation page 3
 Cleaning page 5
 Troubleshooting page 5
 Fuse Instruction page 7

COOKWARE REQUIREMENTS

Compatible

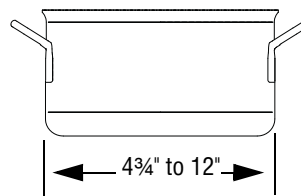

- Flat base 4 $\frac{3}{4}$ " to 12" (12.1 to 30.5 cm) in diameter.
- Ferrous stainless steel, iron, cast iron.

Incompatible

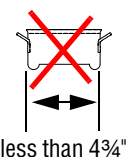

- Base is not flat
- Base is less than 4 $\frac{3}{4}$ " (12.1 cm) in diameter.
- Pottery, glass, aluminum, bronze or copper cookware.

Note: Cookware with inferior construction or material may not perform well. Cookware with a larger base diameter can be used, however, only the area of the cookware above the induction coil will heat. The more cookware extends past the coil, the more the overall performance will be reduced.

ENVIRONMENT REQUIREMENTS

NOTICE: Indoor use only.

NOTICE: Do not place the equipment on or near heat-producing equipment.

NOTICE: This equipment requires a dedicated electrical circuit.



Maximum Ambient Temperature as measured at the air intake. See  below): 104°F (40°C)

CLEARANCE REQUIREMENTS

NOTICE: This equipment is not designed to be enclosed or built into any area. Sufficient airflow must be allowed around the equipment. Blocking the airflow could reduce the performance.

 2" (5.1 cm) minimum clearance  Air intake  Air exhaust

Single Range

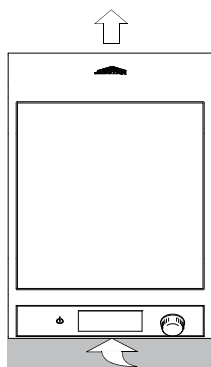

Two Ranges

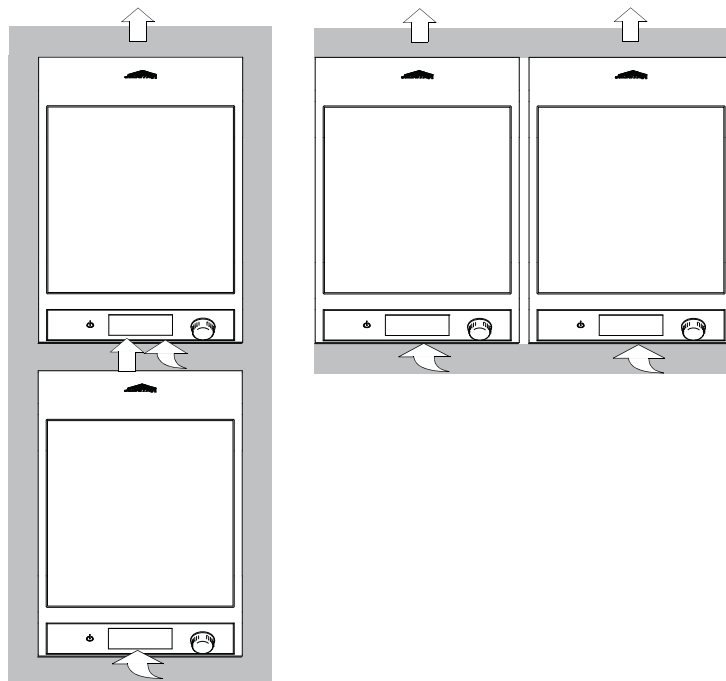

Three or More Ranges Placed Side to Side

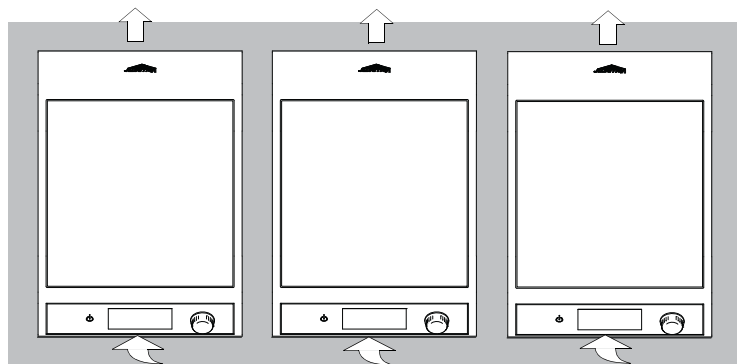

Four Ranges

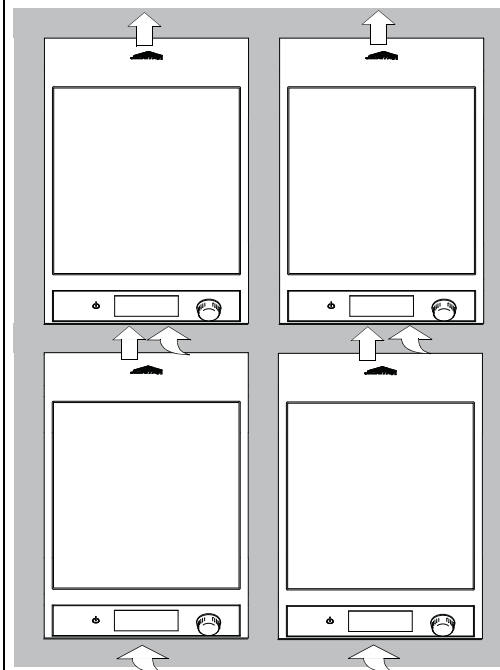

FEATURES AND CONTROLS



- A Control Panel**
B Control Knob. Sets the power level, temperature or time.

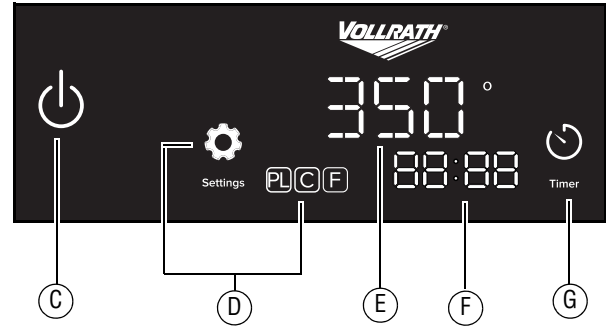

- C Power On/Off**
D Settings

PL 1-100% of power

- Responsive, gas flame-like control
- Use for fast, powerful heating.
- Use for boiling, sautéing, searing, omelets.

C Temperature in °C

- Single degree increments in °F or °C.
- Steady, controlled heating.
- Use for more precise pan control.
- Use for sauces, poaching.

F Temperature in °F

E Power Level and Temperature Display

F Timer Display

G Timer On/Off

OPERATION

	WARNING
Electrical Shock Hazard	
Keep water and other liquids from entering the inside of the equipment. Liquid inside the equipment could cause an electrical shock.	

	CAUTION
Burn Hazard	
Do not touch hot food, liquid or heating surfaces while equipment is heating or operating.	

NOTICE: This equipment requires a dedicated electrical circuit.

NOTICE: Using a voltage other than the nameplate rated voltage, modifying the power cord or electrical components may damage equipment and will void the warranty.

NOTICE: Do not use extension cords, power strips or surge protectors with this equipment.

NOTICE: Do not preheat empty cookware or leave an empty pan on an operating unit. Because of the speed and efficiency of the induction range, cookware can very quickly overheat and be damaged.

NOTICE: Do not drop cooking utensils or other objects onto the cooking surface or control panel. The surfaces could break. The warranty does not cover broken cooktop or control panel glass.

NOTICE: Do not use heat-sealed cans or containers. They may explode.

Turn on the Induction Range

1. Place the induction range on a flat stable surface.
2. Plug the range into an electrical outlet that matches the voltage shown on the rating plate.
3. Place a pan containing food or liquid onto the cooking surface.

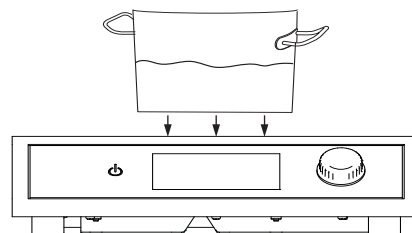







4. Touch

OPERATION

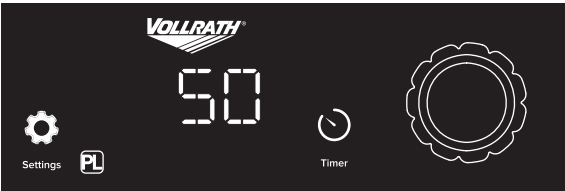
Select a Cooking Method

Choose between power level or pan temperature.

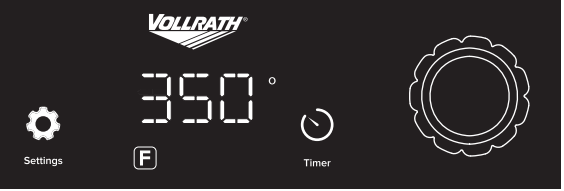
Power Level	OR Temperature
<ul style="list-style-type: none">• Responsive, gas flame-like control.• Use for fast, powerful heating.• Use for boiling, sautéing, searing, omelets. <p>1. Touch  repeatedly until PL is selected.</p> <p></p> <p>2. Rotate  to select a power level.</p> 	<ul style="list-style-type: none">• Single degree increments in °F or °C.• Steady, controlled heating.• Use for more precise pan temperature.• Use for sauces, poaching. <p>1. Touch  repeatedly until C or F is selected.</p> <p></p> <p>2. Rotate  to select a temperature.</p> 

Set the Timer (Optional)

1. Touch .
2. The time will flash.

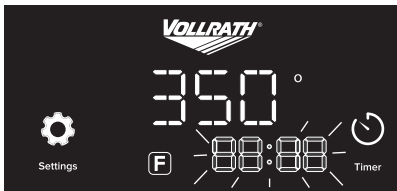

3. Rotate  to select a time in 30 second increments.

After three seconds, the timer will begin to count down and

 will flash to indicate the timer is in use.



4. When the timer reaches zero, a buzzer will sound and the display will show END. Heating will stop.

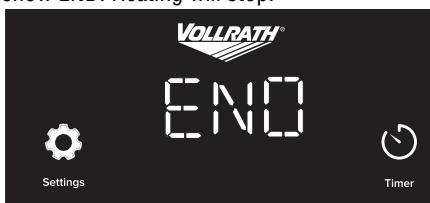

Change the Duration of Time

1. Touch .
2. Rotate  to change the duration of time.

Cancel the Timer

Touch  **x 2**.

CLEANING

To maintain the appearance and increase the service life, clean induction range daily.

	WARNING
	Electrical Shock Hazard Do not spray water or cleaning products. Liquid could contact the electrical components and cause a short circuit or an electrical shock.

	CAUTION
	Burn Hazard Heating surface remains hot after equipment is turned off. Hot surfaces and food can burn skin. Allow the hot surfaces to cool before handling.

NOTICE: Do not use abrasive materials, scratching cleansers or scouring pads to clean the equipment. These can damage the finish. Use only a mild soap.

1. Touch  to turn off the range. The display may show HOT until the cooking surface cools.



2. Unplug the cord from the wall outlet.
3. Allow the equipment to cool.
4. Wipe the exterior with a clean damp cloth.
5. Thoroughly wipe off any soap residue.

NOTICE: Soap residue could corrode the surface of the unit.

TROUBLESHOOTING

Problem	Might be Caused By	Course of Action
The display is flashing.	There is not a pan on the range or the pan is not induction ready.	Place a pan onto the range. Verify the pan is induction ready. See the Cookware Requirements section in this manual.
Message on the Display		
F-01	The range may have overheated because it is too close to heat producing equipment.	Relocate the equipment away from heat producing equipment. Contact Vollrath Technical Services if the problem persists.
F-02	The cookware may have been too hot when it was placed onto the range.	Remove the cookware. Allow it to cool slightly before placing it on the cooking surface. Contact Vollrath Technical Services if the problem persists.
F-05, F-06, F-07, F10, F11, F24, F25	There may be a problem with an internal component.	Try to clear the error by turning the range off, and then on. Contact Vollrath Technical Services if the problem persists.
F-08	The range may have overheated due to insufficient airflow.	Make sure the equipment has adequate airflow. See the Clearance Requirements section in this manual. Verify the air intake under the equipment is not blocked. Contact Vollrath Technical Services if the problem persists.
F16	The sensor may have detected an empty pan was on the range for too long.	Remove the pan. Clear the error by turning the range off, and then on. Place only pans with food in them onto the range.
F17, F18	There may be an issue with the incoming power supply or there may have been a power surge.	Try plugging the range into an a electrical outlet that is on a different circuit. Contact Vollrath Technical Services if the problem persists.
F19, F20	There may be an issue with the incoming power supply quality.	Try plugging the range into an a electrical outlet that is on a different circuit. Contact an electrician to troubleshoot the electrical supply.
F22	The range is plugged into an outlet with the wrong voltage.	Make sure the power at the electrical outlet matches the rating tag on the underside of the range.
	A prolonged power surge.	Try to clear the error by unplugging, and then plugging in the range. Resume operation. Contact Vollrath Technical Services if the problem persists.
F23	The range is plugged into an outlet with the wrong voltage.	Make sure the power at the electrical outlet matches the rating tag on the underside of the range.
	A prolonged dip in the power supply.	Try to clear the error by unplugging, and then plugging in the range. Resume operation. Contact Vollrath Technical Services if the problem persists.
HOT	The user turned off the range. The cooking surface is still hot.	This is normal operation.

TROUBLESHOOTING (CONTINUED)

Problem	Might be Caused By	Course of Action
Cookware is not Heating		
The range turned off after 10 minutes.	There is not a pot or pan on the induction range or it is not induction-ready cookware, so the induction range turned off. This is normal.	Verify the cookware is induction ready. See the Cookware Requirements section of this manual.
The pan suddenly stopped heating. No power level or temperature is displayed.	The timer was in use and time expired. The range stopped heating the pan.	This is normal. A program that includes a timer stage may have been in use or the timer may have been inadvertently activated.
Vollrath logo is not illuminated even though the range is plugged in.	There may be problem with the electrical supply.	Try plugging another piece of equipment into the outlet to verify the outlet is working. Verify the voltage at the outlet matches the voltage rating on the nameplate located on the underside of the range.
	The fuse may need to be replaced.	See "Fuse Instruction" on page 7.
Food Not Heating as Expected		
Food is not heating evenly or seems to be taking too long to heat.	There could be an issue with the cookware.	Verify the cookware is compatible. See the Cookware Requirements section in this manual.
	The food may need more time to heat to the desired temperature.	For faster heating times, try using power level mode instead of temperature mode.
	The cookware may be too large.	With induction cooking, only the area of a pan that makes contact with the induction coil will heat.
	Trying to heat too much food at once.	In general, larger amounts of food take longer to heat. For faster heating times, try heating less food at a time. For best performance, stir food often.
	Insufficient airflow around the range. Ambient temperature may be too high.	Refer to the Clearance Requirements section of this manual.
	The cooking application may not match the intended use of the range.	Vollrath offers induction ranges with different wattages and features designed to fit a variety of applications. Visit Vollrath.com for more information.
Noise		
Grinding, ticking noise, rattle sound coming from the vents.	There may be a problem with the fans.	Contact Vollrath Technical Services.
The fan is running. The range is turned off.	This is normal. The fans will run until the internal components have cooled.	Normal operation.
Range Does Not Turn On		
Range is plugged into a working electrical outlet with correct voltage, but the Vollrath logo is not illuminated.	The fuse may need to be replaced.	See "Fuse Instruction" on page 7.

FUSE INSTRUCTION

The Troubleshooting section of this manual describes situations in which the fuse may need to be replaced.

Determine Type of Fuse

- Internal Fuse - Contact Vollrath Technical Services for support. Internal fuse cannot be serviced by customer.
- External Fuse - proceed to the Tools You Will Need Section to replace fuse.

EXTERNAL FUSE REPLACEMENT

Tools You Will Need

- Small screwdriver.
 - Towel or soft cloth.
 - 314 20A fuse (Available on Vollrath.com and found at most hardware stores).
1. Turn off and unplug the induction range.
 2. Place a towel or soft cloth on a flat, stable surface.
 3. Gently and carefully, lay the induction range, glass-side down, onto the towel. Locate the fuse cap.

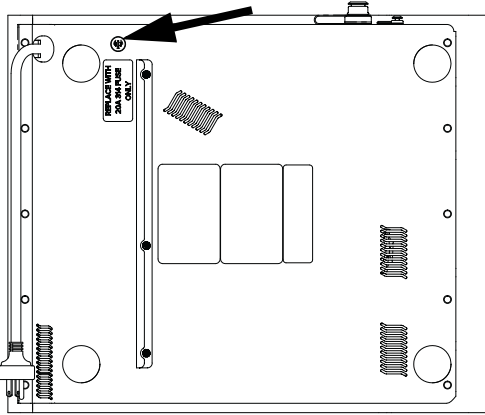

4. Using screwdriver; press down and turn the fuse holder cap to release it from the range.

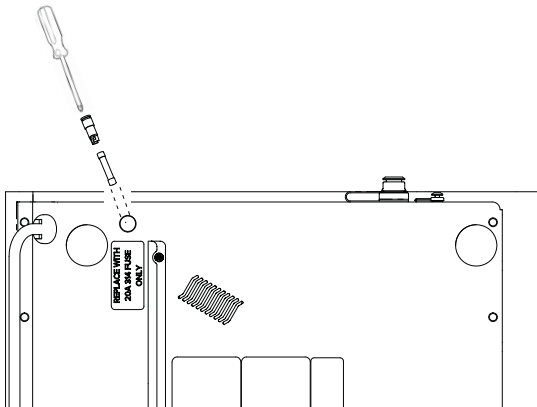

5. Remove the fuse from the holder.
6. Insert a replacement fuse into the holder.
7. Re-insert the holder and use the screwdriver to secure the cap into the range.
8. Ensure the cap holder is locked into place.

INTERNAL FUSE REPLACEMENT

Note: If induction range has an internal fuse you must contact Vollrath Tech Services for support. Internal fuse cannot be serviced by customer.

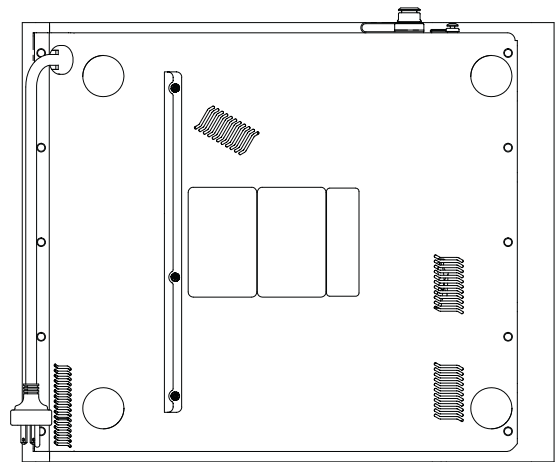

FCC STATEMENT

This equipment has been tested and found to comply with Part 18 of FCC Rules. These limits are designed to provide reasonable protection against harmful interference in a residential installation. This equipment generates, uses and can radiate radio frequency energy and, if not installed and used in accordance with the instructions, may cause harmful interference to radio communications. However, there is no guarantee that interference will not occur in a particular installation. If this equipment does cause harmful interference to radio or television reception, which can be determined by turning the equipment off and on, the user is encouraged to try to correct the interference by one or more of the following measures:

- Reorient or relocate the receiving antenna
- Increase the separation between the equipment and receiver
- Connect the equipment into an outlet on a circuit different from that to which the receiver is connected
- Consult the dealer or an experienced radio/TV technician for help

To assure continued compliance, any changes or modifications not expressly approved by the party Responsible for compliance could void the user's authority to operate this equipment.

SERVICE AND REPAIR

Serviceable parts are available on Vollrath.com.

To avoid serious injury or damage, never attempt to repair the unit or replace a damaged power cord yourself. Do not send units directly to The Vollrath Company LLC. Please contact Vollrath Technical Services for instructions.

When contacting Vollrath Technical Services, please be ready with the item number, model number (if applicable), serial number, and proof of purchase showing the date the unit was purchased.

WARRANTY STATEMENT FOR THE VOLLRATH CO. L.L.C.

The warranty period is 2 years. See Vollrath.com for full warranty details.

This warranty does not apply to products purchased for personal, family or household use, and The Vollrath Company LLC does not offer a written warranty to purchasers for such uses.

The Vollrath Company LLC warrants the products it manufactures or distributes against defects in materials and workmanship as specifically described in our full warranty statement. In all cases, the warranty runs from the date of the end user's original purchase date found on the receipt. Any damages from improper use, abuse, modification or damage resulting from improper packaging during return shipment for warranty repair will not be covered under warranty.

For complete warranty information, product registration and new product announcement, visit www.vollrath.com.



www.vollrath.com

The Vollrath Company, L.L.C.

1236 North 18th Street
Sheboygan, WI 53081-3201 U.S.A.
Main Tel: 800.624.2051 or 920.457.4851
Main Fax: 800.752.5620 or 920.459.6573
Customer Service: 800.628.0830
Canada Customer Service: 800.695.8560

Technical Services

techservicereps@vollrathco.com
Induction Products: 800.825.6036
Countertop Warming Products: 800.354.1970
Toasters: 800-309-2250
All Other Products: 800.628.0832